IOP

Institute of Physics

Combustion Physics Group

NEWSLETTER

April 2010

Issue no. 58

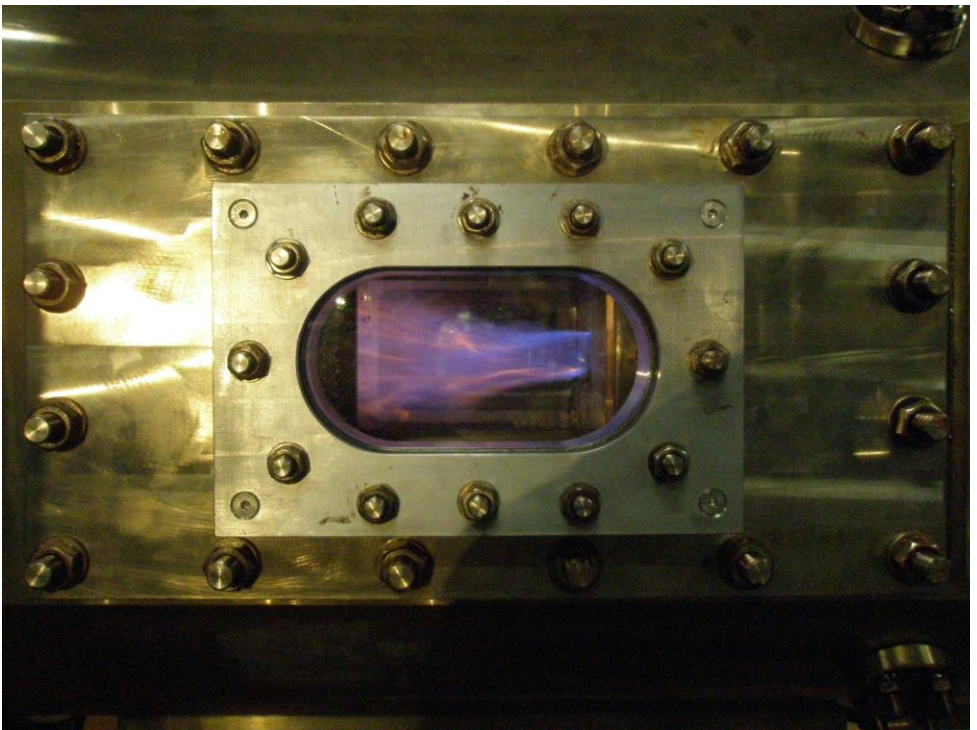

Preliminary tests of High Pressure Optical Combustor at Gas Turbine Research Centre of Cardiff University. Rich premixed methane flame at elevated temperature and pressure conditions.

<http://www.iop.org/activity/groups/subject/comb>

Contents

The Front Page

1.	Editor's corner	3
2.	Meetings and conferences	
	Past meetings and Reviews	4
	Future meetings	14
3.	Contributed articles	
	An Experiment to Investigate the Properties of Bio-fuels and Gasoline at Sub-Zero Temperatures	17
	Word search	20
4.	Group activities	
	Prizes	22
	Contact details	25

The Front Page

This issue's front page was kindly supplied by A. Bagdanavicius, a Marie Curie researcher at Cardiff University, who also presented at our early career researchers meeting, see section 2.2.1 for the full abstract. The image details their high pressure optical combustion chamber at the Gas Turbine Research Centre in Cardiff. The flame itself is a rich methane air flame burning under elevated temperature and pressure.

1. Editor's corner

Welcome to the 58th edition of the Combustion Physics Group newsletter. In this issue we review the latest Early Career Researchers meeting held in Loughborough last year. The winners of the many prizes that we awarded are celebrated and we have included the abstracts of the high quality oral presentations to give those who were unable to attend a flavour of the current research being conducted by enthusiastic early career researchers. We are also pleased to be able to announce the winner of the best thesis prize and the Huw Edwards Services to Combustion award.

We have a number of meetings coming up in the next couple of months and more prizes to announce closing dates for. We are also reminding all students to get their applications in for a travel grant to help fund their trip to the International Symposium on Combustion in Beijing later this year.

I would like to remind all those early career combustion scientists that a £50 reward may be claimed for contributions to the newsletter, which can be used for anything you like, even a few beers in Beijing! Simply send the editor a short piece about your current work in combustion, an historical anecdote, meeting review or anything else combustion related that would be of interest to our readers. Also if your work produces interesting visual records of combustion processes you could be featured on the front page! Send your articles and pictures to catherine.gardner@qmul.ac.uk.

Catherine Gardner.

2. Meetings and Conferences

2.1. Past Meetings and Reviews

2.2. Current Research in Combustion: A Forum for Research Students and Early Career Researchers

James France Centre, Ashby Road, Loughborough, 22nd September 2009

The Early Career Researchers meeting is held every two years and aims to encourage PhD students and early career researchers to present their work in a forum dedicated to current research in combustion physics. The event also provides an excellent opportunity to meet other researchers from both academia and industry. The meeting included oral and poster presentations from leading research groups in the field of combustion physics and covered various aspects of combustion research.

This year three prizes were up for grabs in total, the Felix Weinberg prize for the best oral presentation, the British Flame prize for the best industrially relevant presentation and a prize for the best poster presentation.

This year the oral presentations focused on quite many different aspects of combustion research, from laser based techniques to determine the influence of turbulence in the cylinder of an IC engine, to smouldering peat fires that can burn for decades in many areas around the globe. The presentations were made by early career researchers from both academia and industry, and during the lunch break there was an array of posters to peruse and discuss with the enthusiastic presenters.

The abstract for each of the presentations are detailed below and the winners were as follows;

Young Researchers Meeting Prizes
Weinberg prize for best presentation. Sponsored by the IOP £100 and a certificate: John Rimmer Runner up receives a certificate Rishin Patel
Best Poster presentation: Certificate Aminuddin Saat Runner up: Mohammed Abdulsada
Presentation: Best Industrially relevant research Sponsored by British Flame. £250 and a certificate: Aminuddin Saat

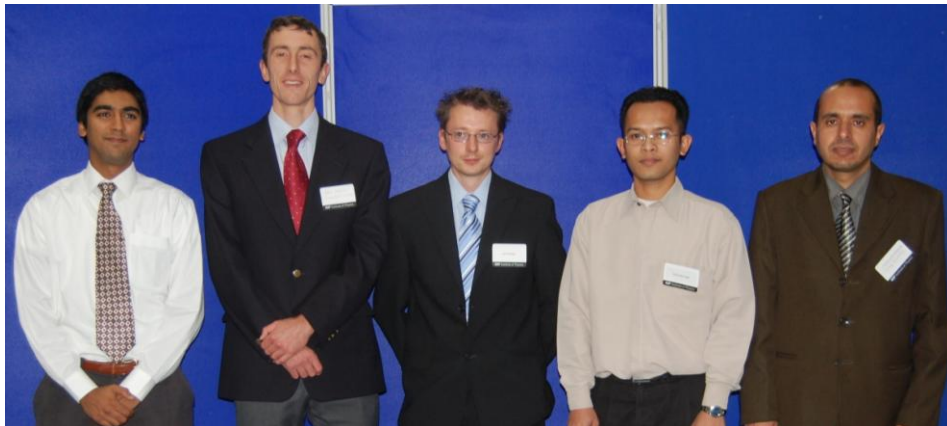

Prize winners from the Early Career Researchers meeting; (L-R) Rishin Patel, Robert Patterson, John Rimmer, Aminuddin Saat, Mohammed Abdulsada.

We were also pleased to be able to present a certificate to the co-author of the Ricardo prize for best UK paper in 2008, Robert I. A. Patterson. His paper with Markus Kraft from the Department of Chemical Engineering, University of Cambridge, entitled "Models for the aggregate structure of soot particles", and published in *Combustion and Flame* (Volume 151, Issues 1-2, October 2007, Pages 160-172.) was considered to be the best paper produced by a UK based research group in 2009. This prize was also celebrated at our awards dinner where Phil Bowen presented Markus Kraft with his certificate.

See the Prizes section for details of how to nominate for upcoming awards.

2.2.1. Abstracts from oral presentations.

Smouldering Combustion Phenomena in Science and Technology

Dr Guillermo Rein

School of Engineering, University of Edinburgh

Smouldering is the slow, low-temperature, flameless form of combustion of a condensed fuel. It poses safety and environmental hazards and allows novel technological application but its fundamentals remain mostly unknown to the scientific community. This talk starts by identifying the physical and chemical mechanisms involved in smouldering, and presents the governing equations. Different smouldering phenomena are then discussed. The overall goal is to synthesize a comprehensive view of the process across diverse scientific disciplines.

The propagation rate of a self-sustained smouldering front is controlled by oxygen transport and net heat losses. Yet, heterogeneous chemical kinetics governs the front structure and dictates the effective heat released. The degradation of a solid fuel involves multiple pathways to chemical changes, pyrolysis and oxidation, but these pathways are not yet fully understood.

Most smouldering phenomena of importance are related to human and environmental hazards. Smouldering is the leading cause of deaths in residential fires and a source of safety concerns in space and commercial flights. Smouldering wildfires destroy large amounts of biomass and cause damage to the forest soil. Subsurface fires of coal deposits burn for very long periods of time, making them the oldest continuously burning fires on Earth (up to 6,000 years). They contribute significantly to atmospheric pollutant and green house gas emissions. It has been calculated that 13–40% of the 1997 global carbon emissions were released to the atmosphere during the 1997 Indonesia smouldering fires.

Worthy of consideration are the novel environmental and energy technologies being developed based on the direct application of smouldering combustion. These include the remediation of contaminated soils, the production of biochar for long term storage of carbon in the solid phase, the enchanted oil extraction from ground reservoirs and the in-situ gasification of deep coal seams.

The prospect of new opportunities for science and engineering in smouldering combustion are noticeable, but a much larger international research effort is required to increase the number of multidisciplinary experimental, theoretical and field studies.

Large Eddy Simulation of Diesel Engine Combustion with Conditional Moment Closure

**F. Bottone^(a), A. Kronenburg^(b), A.D. Gosman^(a), A. Marquis^(a),
E. Mastorakos^(c)**

(a) Department of Mechanical Engineering, Imperial College London

(b) Institut für Technische Verbrennung, Universität Stuttgart

(c) Hopkinson Laboratory, Department of Engineering, University of Cambridge

In order to improve the prediction of pollutant formation in Diesel Engines, it is necessary to take accurately into account mixing of fuel and oxidizer, turbulence-chemistry interactions and cycle-to-cycle variations.

Over the past three decades most of the CFD research for Internal Combustion Engines (ICE) has been successfully carried out using the Reynolds Averaged Navier Stokes (RANS) approach. Despite the achievements obtained in engine design, the RANS models have limits that Large-Eddy Simulation (LES) can overcome. Contrary to RANS approach, in LES it is possible to access a single realization of the flow field, which allows to have a better description of the in-cylinder flow motion and have access to the cycle-to-cycle variations.

In this work LES is combined with the Conditional Moment Closure method, which is considered an effective method for the simulation of non-premixed combustion. The main idea is to exploit the advantages of coupling LES and CMC for Diesel engine simulations. In non-premixed combustion such as Diesel combustion, mixing of fuel and oxidizer plays a key role and LES can provide a detailed description of the mixing field, which leads to improved closure models in the CMC equations.

In the present study numerical simulations of a single-cylinder four-valve direct-injection engine have been computed. The engine is a 500 cc optical engine for which experimental data under motored and fired conditions are available. The simulations have been carried out coupling an unsteady three-dimensional CMC code with a commercial CFD code, STAR-CD.

The numerical model of the engine consists of a full 360 degree computational mesh of about 1.4 million cells at bottom dead center, with an average grid

spacing of 0.75 mm; the motion of the piston and of the valves has been included in the simulation.

The CMC equations are solved using an operator splitting approach over a structured CMC grid, which is interfaced with the CFD mesh. A cell addition/removal algorithm is used to represent the moving grid. A detailed n-heptane reaction mechanism has been implemented to simulate the diesel fuel chemistry.

Some preliminary results for both motored and fired conditions are presented. Cold flow simulations with and without spray injection have been performed with the purpose of gaining an insight of the in-cylinder motion and the interaction with the jet spray. In fired condition, a closed-cycle mesh has been used, for which valve motion has been neglected. Results have been compared with previous RANS-CMC simulations in engine-like conditions and with experimental data.

These preliminary results show that the present model is capable of capturing the overall combustion process and can be further developed into a truly predictive combustion model for Diesel engine simulation.

Investigation of turbulent premixed hydrogen enriched methane flames at elevated temperature and pressure

A. Bagdanavicius, P. J. Bowen, N. Syred

Cardiff University, Cardiff School of Engineering, The Parade, Cardiff CF24 3AA
Wales, UK

An increasing interest in alternative fuels for gas turbines stimulates the research in gaseous fuels enriched with hydrogen. The hydrogen or hydrogen enriched premixed fuel combustion research at atmospheric conditions and at elevated pressure conditions for laminar and turbulent flames has been performed by many researchers; however most of these investigations have been performed using propagating flames.

The tests, reported here, were performed in the High Pressure Optical Chamber (HPOC) which is located within the Gas Turbine Research Centre of Cardiff University using 100% methane, 85% methane – 15% hydrogen and 70% methane – 30% hydrogen mixtures. The HPOC consists of a horizontally mounted Bunsen burner within an inner combustion chamber, optical pressure casing and heat exchanger. Approximately 30 sets of tests for each gas mixture were carried out at different pressures, temperatures, and equivalence ratios for the following testing conditions:

- 3 bara and 7 bara pressure,
- 473 K and 673 K temperature,

- lean and rich mixtures from 0.65 to 1.45.

Turbulent burning velocity of gas mixtures was calculated using two different image processing techniques: traditional averaged flame image processing method and statistical single flame image treatment method. Turbulent characteristics were calculated and turbulent burning velocity correlations with Damkohler and Karlovitz number were found. Important turbulent flame characteristics, such as: flame brush thickness and flames surface density were calculated.

Combustion Diagnostics of a Dual-Fuel Engine via a Three-Zone Model for Heat Release Rate Analysis

Jill Stewart

This abstract describes a research project that delivered a step-change in fundamental knowledge of the combustion processes in a dual-fuel engine. The term 'dual-fuel' refers to a compression-ignition engine where a small quantity of diesel (called the pilot) is used to ignite a second, gaseous fuel, which is the primary energy source. The motivation to use dual-fuel is often economic, as the primary fuel is frequently less expensive than the distillate fuel it replaces. However, some benefits in terms of the reduced emissions of smoke and oxides of nitrogen (NO_x) can also be achieved.

In this research, a small, direct-injection diesel engine was converted to dual-fuel operation. Although this type of engine is numerous, and typical of those used in stationary power generation applications, small high-speed industrial engines have received less research attention than their automotive counterparts as they have (historically) been subject to less stringent emissions legislation. An experimental programme was conducted using this engine to record its performance and emissions trends, whilst being dual-fuelled with methane, under operating conditions that represent this engines typical duty cycle; i.e. steady-state operation at 1500rpm (synchronous speed) and 0, ¼, ½, ¾ and full load.

The type of experimental data that was delivered through the research programme would have previously been examined using a single-zone model for heat-release rate analysis. In this work, a new, three-zone model for heat release rate analysis was developed, as this new approach allows dual-fuel engine data to be examined with a tool that is physically representative of the conditions encountered within the engine: the pilot is injected as a fuel rich zone into an unburned zone consisting of air, the primary fuel and residual gases. Upon the start of combustion, a burned zone containing the equilibrium products of combustion is then formed. The performance of the three-zone model was then bench marked against the single-zone model. By means of this comparison, it

was shown that the single-zone method is unable to adequately represent the physical processes occurring in the more complex, multi-fuel combustion system. In particular, the three-zone method showed that the theory which describes the pilot as burning in two separate, initial stages was found to rest upon a modelling artefact induced through single-zone techniques, and therefore, is incorrect.

It was also found that as the proportion of the methane fuel was increased, the combustion process retained similar characteristics and magnitudes of mass burned to diesel combustion until all but the highest equivalence ratios. At this point, the premixed and diffusion burning periods merged, but continued to show a fundamental dependence on the pilot ignition, and the combustion processes were never seen to become independent of the pilot. The range of equivalence ratios over which the premixed and diffusion burning periods merge, is firstly a function of the primary fuel, and secondly a function of the operating conditions (such as elevated in-cylinder temperature at higher loads).

It is proposed that the dual-fuel combustion process is better described as a diesel combustion process with a modified diffusion burning period that results from the gaseous fuel concentration. By using this explanation, it was identified that the emissions characteristics of the engine could be modified through the use of a second fuel. The primary fuel can reduce the initial mass burning rates (to reduce NO_x) and simultaneously elevated the diffusion burning rates (to reduce smoke emissions). This provides an alternative, beneficial means by which the classic diesel NO_x-particulate trade-off can be manipulated.

The Influence of In-Cylinder Turbulence upon Combustion Processes within a Direct Injection IC Engine

J. E. T. Rimmer

Wolfson School of Mechanical and Manufacturing Engineering, Loughborough University, Loughborough, Leicestershire, LE11 3TU, UK

ABSTRACT

It is widely accepted that engine combustion is fundamentally affected by the in-cylinder charge motion. Flow field structures present at the time and location of spark ignition are known to have a controlling effect on early flame development. Therefore, improved understanding of the variation in flow field structures local to the spark plug at the time of ignition is required. The purpose of this research has been to investigate the effect specific scales of turbulent flow structure has on combustion within a direct injection spark ignition (DISI) engine (Figure 1).

High speed particle image velocimetry (HSPIV) has been used to quantify the flow field leading up to and following spark ignition. HSPIV data was recorded at a rate of 5 kHz, providing a temporal resolution of 1.8 crank angle degrees (CAD) between measurement fields and a spatial resolution of 512 by 512 pixels (Figure 2). Velocity field measurements were acquired over a 70.2° crank angle (CA) range, from 300° CA to 370.2° CA after top dead centre (ATDC), spanning spark ignition (325° CA ATDC).

The levels of turbulence that exist within each cycle have been calculated as a root mean square (RMS) velocity and compared to engine performance indicated mean effective pressure (IMEP) and mass fraction burnt (MFB). In order to determine the range of spatial and temporal scales of turbulence that affect the burn rate and IMEP, frequency analysis was carried out upon the velocity field data. This analysis was achieved by FFT filtering the HSPIV data captured in the vicinity of the spark plug, separating the velocity fields into low frequency bulk motion and high frequency turbulence components. The data demonstrates that removing fluctuating components with a frequency below 240 Hz successfully removes the variation in bulk motion from the calculation of turbulence intensity, revealing the relationship between high frequency turbulence and charge consumption. Moreover, FFT filtering of fluctuating components above 600 Hz reduced the correlation between high frequency turbulence and IMEP (Figure 3), demonstrating the influence of these high frequency/small scale turbulent structures on flame propagation rate, and thereby rate of charge consumption and engine performance.

An experimental approach to model validation for large-eddy simulations of turbulent premixed flames

Johannes Kerl and Frank Beyrau

Department of Mechanical Engineering, Imperial College London, SW7 2AZ
London, UK j.kerl08@imperial.ac.uk; f.beyrau@imperial.ac.uk

Large eddy simulations (LES) require a spatial filtering operation for the governing equations. This results in several new terms, which need closure by so called subgrid-scale (SGS) models. For example for the description of premixed flames, models for the filtered reaction rate $\tilde{\omega}$, the scalar flux of the reaction progress variable $J_i^{SGS} = \tilde{u}_i \tilde{c} - \tilde{u}_i \tilde{c}$ and the filtered SGS stresses $\tau_{ij}^{SGS} = \tilde{u}_i \tilde{u}_j - \tilde{u}_i \tilde{u}_j$ are needed. This represents quite a challenge since the filter size is typically larger than the actual reaction zone. Moreover, most of the SGS models require simultaneous data for the local density, the reaction progress variable and the

three-dimensional flow-field. Now in order to establish and to validate such models, spatially highly resolved data sets of the relevant quantities are required, ideally for flames at high Reynolds numbers to resemble technical burner systems.

In this work, we present an experimental approach to the investigation of SGS models of turbulent premixed flames which is mainly based on a high-resolution dual plane stereo-PIV system. With the flamelet assumption the local gas density and the reaction progress variable are binary distributed and can be deduced from the PIV raw images using the clearly visible step in the particle density as a flame front marker and the binarized particle densities as a marker for burnt and unburnt regions. The velocity field is then calculated from the particle images using the common stereo-PIV procedure. A detailed proof of this measurement concept can be found in [1].

Using two stereo-PIV system with parallel planes, the 3D velocity field of the flame can be acquired, see e.g. Ref [2]. By spatial averaging over several regions of interest (which reproduces the application of a filter length in LES), the measured data can directly be compared with filtered LES quantities [3]. This 3D measurement approach allows the calculation of filtered derivatives in all three directions of space which facilitates the analysis of the density weighted filtered deformation tensor \tilde{S}_{ij} as a field variable. This symmetric tensor constitutes a central quantity for SGS modelling. We present the fundamental principles of the described approach as well as some results from measurements.

References:

- [1] S. Pfadler, F. Beyrau, A. Leipertz, Flame Front Detection and Characterization using Conditioned Particle Image Velocimetry (CPIV). *Optics Express* **15**, 15444-15456 (2007)
- [2] J.A. Mullin, J.A. Dahm, Dual-plane stereo particle image velocimetry (DSPIV) for measuring velocity gradient fields at intermediate and small scales of turbulent flows. *Experiments in Fluids* **38**, 185-196 (2005).
- [3] S. Pfadler, J. Kerl, F. Beyrau, A. Leipertz, A. Sadiki, J. Scheuerlein, F. Dinkelacker, Direct evaluation of the subgrid scale scalar flux in turbulent premixed flames with conditioned dual-plane stereo PIV. *Proceedings of the Combustion Institute* **32**, 1723-1730 (2009)

A Multi-fuel, Variable Compression, Two Stroke HCCI Engine

Rishin Patel

Lotus Engineering, Norwich, UK

The Homogeneous Charge Compression Ignition combustion process, HCCI, offers significant advantages in terms of lower pollutant emission and fuel economy benefits. Adopting this combustion system in an internal combustion engine has been met with numerous challenges, in particular the restricted speed/load map over which it can be used implies that a change from auto-ignition to spark ignition is required many times throughout a drive cycle. In conjunction with this switch over there is an associated problem of trying to maintain a constant torque during these changes, to aid the driveability of the vehicle.

This research programme is aimed at significantly enlarging the load/speed map over which HCCI can be applied by coupling the synergies of HCCI and the Two-stroke engine cycle. Unique to this project is the research engine which comprises a moveable puck in the cylinder head which permits the compression ratio to be varied continuously between 10:1 and 40:1. The engine also features a charge trapping valve on the exhaust port to provide for variable amounts of trapped exhaust gas recirculation, EGR. The engine named Omnivore, as a result of its potential to be run on a wide range of different fuels, may be operated with excessively lean charge mixtures as a result of the variable compression ratio as well as with large amounts of EGR. The lean charge serves to deliver reductions in fuel consumption and hence lower carbon dioxide emissions and in combination with the high EGR content delivers very low engine-out nitrous oxides due to the reduced combustion temperatures.

This presentation will give an outline of the aims and objectives of this research project and describe the engine, including the functioning of the variable compression ratio and the exhaust valve. At this early stage of the research, only measurements with gasoline fuel have been performed, and some of the results from these measurements will be presented with a description of the combustion analysis being used to judge the quality of the combustion. This analysis takes the form of the in-cylinder pressure signal processing giving the rate of heat release, mass fraction burnt, power in terms of the indicated mean effective pressure (IMEP) and the coefficient of variance of IMEP which is an indicator of combustion stability from cycle to cycle. There will also be a brief description of the future work to be undertaken with regard to alternative fuels.

2.3. Future Meetings

2.3.1. Low NO_x Combustion, East Midlands Conference Centre, University of Nottingham, 21st April 2010.

A joint meeting organised by the Institute of Physics Combustion and Environmental Physics Groups

This meeting will be of interest to academics and industrialists alike and will bring together experts in combustion processes and in the impacts of combustion products on human health and in the environment. The focus will be on nitrogen oxides (NO_x), delivered through a series of invited talks providing high quality reviews on relevant topics.

Programme

10:30 Registration & Coffee

Session 1 Chair: Mike Welbourne, Welbourne Associates

11:00 Prof. R.P. Lindstedt, Imperial College, "Fundamentals of NO_x Chemistry"

11:45 Dr. Claire Holman, Peter Brett Associates, "Sources of NO_x, trends and legislation"

12:30 Professor David Fowler, Centre for Ecology & Hydrology, Edinburgh, "Impacts of NO_x in the Environment".

13:15 – 14:15 Lunch

Session 2 Chair: to be confirmed

14:15 Speaker to be confirmed, "Transport and urban air pollution"

15:00 David Graham, E.ON, "NO_x emissions from power generation"

15:45 Dr. K. Young, Rolls-Royce, "NO_x from gas turbines"

16:30 Close & Tea

Registration is required for this meeting, and further information is available on the Environmental Physics and Combustion Physics Group web sites and at <http://www.iop.org/Conferences/y/10/lownox/index.html>. .

2.3.2. **Workshop of Analytical Methods in Thermo-acoustics, 24 - 26 May 2010**

A series of lectures, combined with hands-on exercises, will give an introduction into modern analytical methods for modelling sound produced by combustion and vortices as well as sound/structure interaction. The workshop is targeted at researchers in academic and industrial institutions with an interest in modelling combustion instabilities. Some background in fluid mechanics and engineering mathematics will be expected of the workshop participants. Analytical methods in thermo-acoustics not only provide quantitative information for the validation of numerical methods, but they also give important physical insight into combustion instabilities.

List of lecturers:

Professor Michael Howe (Boston University, USA)
Dr Karthik Balachandran (LMS International, Leuven)
Professor John Chapman (Keele University)
Dr Maria Heckl (Keele University)

Venues:

School of Computing and Mathematics, Keele University, Staffordshire ST5 5BG, and the nearby conference hotel Wychwood Park, Weston, Crewe, Cheshire CW2 5GP. Transport between the two venues will be provided. This event is the third in a series of workshops within the FP7 project LIMOUSINE and is held with support from the European Commission. Researchers, who are interested in the workshop, but not partners in the LIMOUSINE project, are also very welcome.

Please see <http://www.scm.keele.ac.uk/limousine/index.php> for more details and registration.

2.3.3. **33rd International Symposium on Combustion, Beijing, China, 1st-6th August 2010.**

The 33rd International Symposium on Combustion will be hosted by Tsinghua University, Beijing, China. As always the IOP combustion physics group will be supporting students who wish to attend through the research student conference fund. Applications should be made to the IOP directly, further instructions can be found at www.iop.org, also see the flyer below.

For more information, including instructions for submission of work in progress poster presentations please go to <http://www.combustion2010.org/>.



Supporting research students

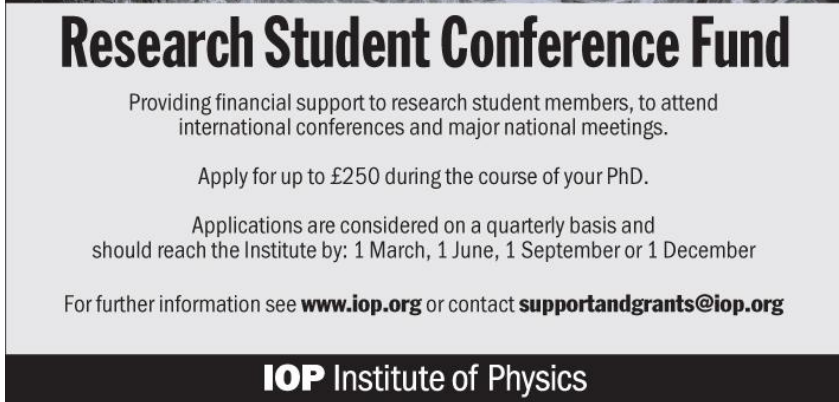

Research Student Conference Fund

Providing financial support to research student members, to attend international conferences and major national meetings.

Apply for up to £250 during the course of your PhD.

Applications are considered on a quarterly basis and should reach the Institute by: 1 March, 1 June, 1 September or 1 December

For further information see www.iop.org or contact supportandgrants@iop.org

IOP Institute of Physics

2.3.4. Preliminary Announcement

Combustion Institute Meeting and AGM -- Gas turbine combustion

The Combustion Institute, British Section, will be hosting a one-day meeting and members Annual General Meeting on **15 September 2010**, in the Engineering Department at the University of Cambridge, on the theme of **gas turbine combustion**.

The meeting will count on talks from members from industry and academia investigating topics on emissions, relight, thermoacoustics and new technologies. A poster session will be held during lunch. Members are encouraged to submit posters on related topics. An award will be made to the best poster in the session.

3. Contributions

3.1. An Experiment to Investigate the Properties of Bio-fuels and Gasoline at Sub-Zero Temperatures

Ifan Evans, PhD Student, Cardiff School of Engineering, Cardiff University

With the world's crude oil resources diminishing and the use of all liquid fuels, including those for road transport set to increase by one third by the year 2030, see figure 1, combined with the effects of climate change, the need to find an alternative to fossil derived fuels is greater than ever. Bio-fuels such as bio-ethanol and bio-methanol are seen as possible substitutes. However, earlier this year both the UK and European governments decreased their targets for bio-fuel integration into road transport fuel. In the UK it was lowered from 5% by 2010/11 to 5% by 2013/14 after the release of the UK government sanctioned Gallagher Review. The Gallagher Review highlighted concerns over the net carbon emissions of first generation bio-fuels such as soya and corn derived bio-fuels. The problem with these fuels are that they have the potential to release more CO₂ into the atmosphere than fossil fuels due to harvesting methods and the effect of land clearing, and there is a possible conflict between food and fuel production. However, with the advent of second generation bio-fuels such as bio-ethanol from waste plant stalks, household waste and prairie grass, as well as bio-butanol produced from algae some of the concerns raised by the first generation fuels can be addressed.

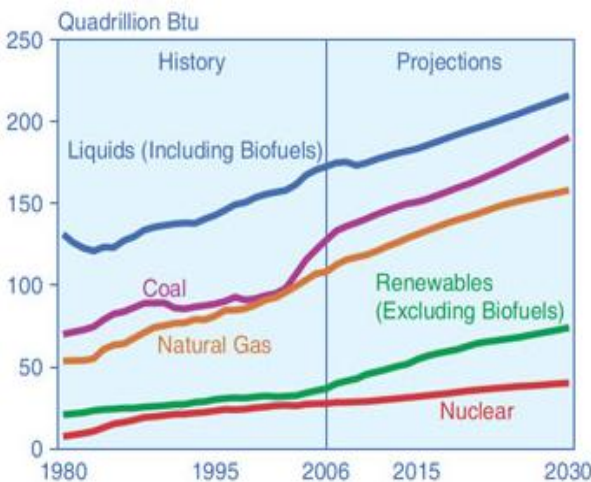

Figure 1: World market fuel use by type, 1980 - 2030.
 2006: Energy Information Administration (EIA) International Energy Annual 2006. Projections: EIA, World Energy Projections Plus 2009

One of the key restricting factors in the implementation of bio-fuels as a substitute for gasoline is their increased viscosity and surface tension. The effects of which are magnified at sub-zero temperatures, leading to poor atomisation and thus difficulty igniting the charge during cold starting of an SI-IC (spark ignition internal combustion) engine. Also the rich fuel mixture present during the warm up period of an IC engine may increase un-burnt hydrocarbon and carbon monoxide emissions. This project is concerned with the effects of both sub-zero and ambient fuels sprays into both ambient and sub-zero atmospheres. It is hoped that this experimental program will quantify the effects of sub-zero temperatures on both bio-ethanol and gasoline sprays, as well as blends of the two, to enable better design of components for more efficient combustion at lower temperatures.

The Cardiff-Ricardo High Pressure, High Temperature (HT-HP) rig was originally developed ten years ago at Cardiff University. It is a large stainless steel vessel with four optical access points so that various laser and high speed imaging techniques can be used to quantify liquid sprays, as shown in Figure 2 a & 2 b. It was initially developed to create an elevated temperature atmosphere into which sprays could be fired and measured. The scope of this project means that it is necessary for the fuel temperature, and the ambient temperature in the chamber, to be lowered to approximately -25°C .

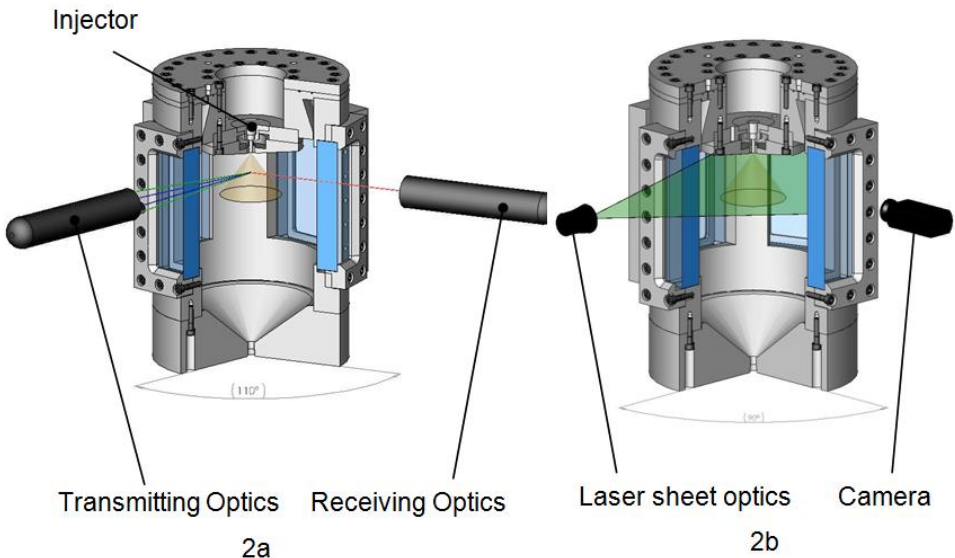

Figure 2: Schematic of the HT-HP rig setup for (a) PDA system (b) PIV and planar imaging.

As the test rig was originally designed to be operated with an elevated atmospheric temperature by using heated air, the logical choice was to use the same air diffusion method to deliver cold air into the vessel and therefore cool the rig. After conducting a detailed literature review into cooling methods it was determined that an expansion of liquid nitrogen was the most appropriate method to create a controllable sub zero atmosphere inside the test vessel. As air consists of approximately 80% nitrogen it was judged that creating an almost 100% nitrogen atmosphere would have no adverse effect on the sprays. Due the large cooling capacity of liquid nitrogen the flow rate of air is low and therefore does not have any recordable effects on the spray itself. Maintaining optical access during the experiment is critical. The low thermal conductivity of glass type materials means that frosting of the optical access windows only occurs after long running times. Dried air is blown over the exterior of the windows helping to prevent the build up of condensation that may limit optical access.

To achieve the level of fuel cooling required over the course of a day's testing liquid nitrogen was used again, in conjunction with a purpose built heat exchanger, to enable the delivery of fuel at a constant -25°C to an injector mounted at the top of the chamber, as shown in figure 2a. The injector used in this experimental rig is a Piezo-electric 'A-nozzle' type injector. In comparison to solenoid type injectors the Piezo-electric type offer better quality spray characteristics and a higher degree of injector control, these characteristics enable more precise fuel delivery for both stratified and homogenous firing. Piezo type injectors are approximately three times more expensive than normal solenoid types, however, as technology progresses it is expected that the cost of these types of injectors will equalise.

Two bio-ethanol blends are proposed for the initial test phase, namely E100 and E85, with the possibility of testing M30 and E30 in future phases. Each fuel will be subjected to tests at three fuel and chamber temperatures, ambient, -10 and -20°C . The test matrix is shown in Figure 3. Biofuel results will be compared with gasoline data recorded under the same conditions as a benchmark.

Test Matrix for all Biofuels and Gasoline.		Fuel Temperature [$^{\circ}\text{C}$]		
		20	-10	-25
Ambient Chamber temp [$^{\circ}\text{C}$]	20	✓	✓	✓
	-10	✓	✓	✓
	-25	✓	✓	✓

Figure 3: Summary of test matrix

Phase Doppler Anemometry (PDA) will be used to quantify the spray characteristics, deducing droplet sizes and droplet velocities. The mass flow rate of the injector will also be quantified and a high speed camera will also be used to assess the developing spray globally as it develops. The data gathered will also be compared to CFD models.

Overall it is hoped that the data gathered will aid in determining methods to facilitate the reduction of harmful emissions during cold start and warm-up periods of a SI-IC engine as well as contributing to increased efficiency.

Editor – I am looking forward to seeing some of the results of this study in the next issue lfan!

3.2. Word Search

In our last newsletter we featured a curiously cryptic crossword sent in by Geraint Thomas and Sian Jones in Aberystwyth. Feedback has suggested that it was quite difficult to complete, so you will be pleased to see that the answers are included in this issue. As a further brain teaser the answers have been incorporated into a word search to keep you occupied on your twice yearly tea break! See the next page...

And for those of you who would like to know the crossword results in full;

ACROSS

5. Activation Energy, 8. LIF, 10. Enthalpy, 11. Soot, 13. Spark, 16. Markstein
17. Octane

DOWN

1. Nondimensional, 2. Detonation wave, 3. Arrhenius Rates, 4. Entropy, 5.
Autoignition, 6. Incinerate, 7. Turbulent, 9. Radical, 12. Swan band, 14. Knock,
15. Bunsen

Once again I would like to remind everyone that all contributions to the newsletter are welcome and that if you are an early career researcher you will receive £50 for your contribution to spend on whatever you like. Simply send you research articles, reviews of current combustion in the media or combustion related brain teasers to me at catherine.gardner@qmul.ac.uk.

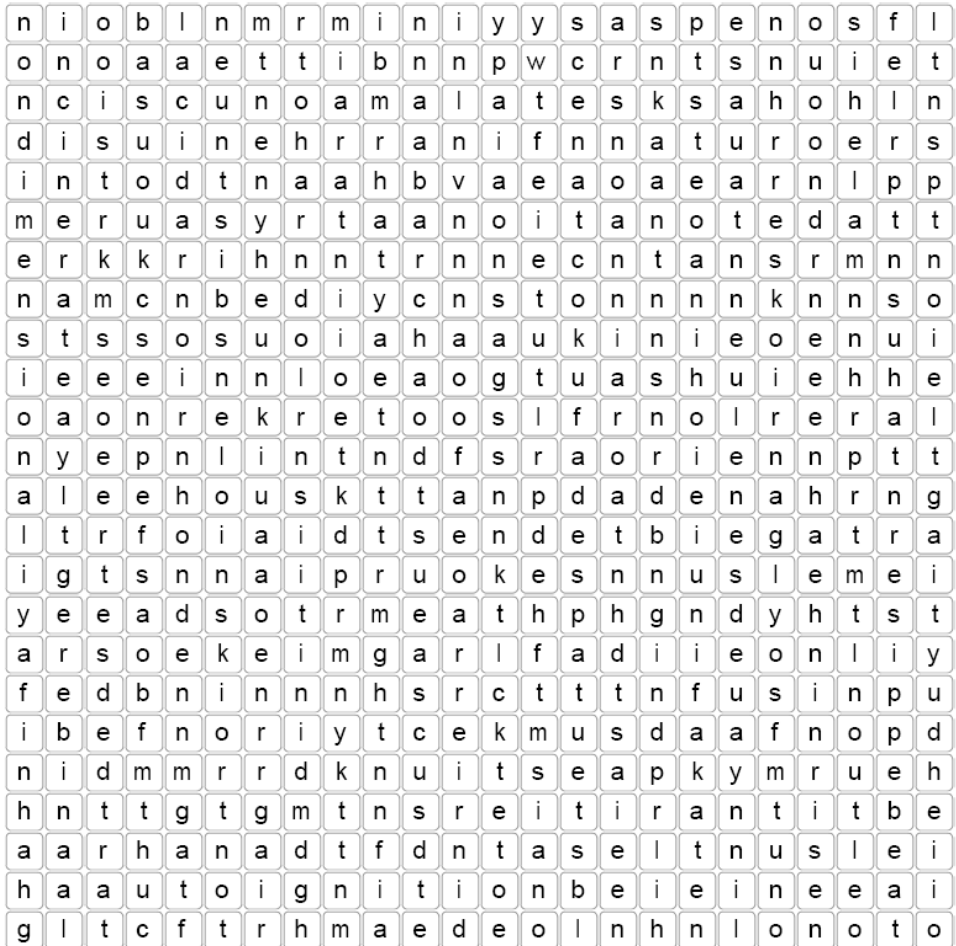

Words to find:

activationenergy, arrhenius, autoignition, bunsen, detonation, enthalpy, entropy, incinerate, knock, lif, markstein, nondimensional, octane, radical, soot, spark, swanband, turbulent.

4. Group activities

4.1 Prizes

Lefebvre Prize for Best UK PhD Thesis in the Field of Combustion Physics

The Lefebvre Prize is a prize for the best thesis accepted by a UK or Irish University, awarded by the Institute of Physics Combustion Physics Group. The prize is awarded biennially and was awarded for the first time in 2009. Theses are judged according to the significance of the contribution to the field of combustion and any difficulties that may have been overcome. The PhD can be in any field of combustion physics such as diagnostics, measurements or computation. Nominations are sought from PhD supervisors, and should include an extended abstract and supporting letter from the thesis examiners. The letter may be substituted with a copy of the report submitted by the examiners to the University after the thesis viva voce examination.

The winner of the **Lefebvre Prize for Best UK PhD Thesis in the Field of Combustion Physics 2009** is **Dr. Giorgio De Paola**, who has produced an exceptional thesis entitled **"Conditional Moment Closure for Autoignition in Turbulent Flows"**

The PhD was awarded in November 2007 and the work has not only been published in five journal papers, but has also been presented at international conferences. In his thesis Dr De Paola developed the first-ever full second-order conditional moment closure (CMC) formulation for auto-ignition, producing the most complete treatment of conditional fluctuations on the chemical reaction rate available. This is a substantial and important contribution to the field of non-premixed reacting flow modelling.

Dr De Paola also developed a numerical solver for the CMC turbulent combustion model and applied it to various auto-ignition situations, such as the first-ever multi-dimensional CMC simulation of engines and constitutes the state-of-the-art in diesel engine modelling [2], applications of CMC to high-pressure bombs with liquid fuel injection [4, 5] and validation of the code and model against a fundamental turbulent auto-ignition experiment [3].

A testament to the substantial impact that Dr De Paola's thesis has had on CMC modelling is that his publications have begun to attract citations and his code has been installed in various laboratories in the world. It has also served as the basis for very important new developments such as implementations of multi-dimensional CMC in Large Eddy Simulation (LES). Dr De Paola's code

developments have enabled the simulation of challenging phenomena that has previously not been possible.

Dr De Paola now works for CD-adapco (the company that developed the engine CFD code "STARCD") in New York and is extending the CMC model to new areas, such as sprays.

References:

1. Second-Order Conditional Moment Closure Simulations of Autoignition of an n-heptane Plume in a Turbulent Coflow of Heated Air De Paola G, Kim IS, Mastorakos E FLOW TURBULENCE AND COMBUSTION, 82(4), 455-475, 2009
2. Diesel engine simulations with multi-dimensional conditional moment closure De Paola G, Mastorakos E, Wright YM, et al. COMBUSTION SCIENCE AND TECHNOLOGY, 180(5), 883-899, 2008
3. Measurements and simulations of mixing and autoignition of an n-heptane plume in a turbulent flow of heated air Markides CN, De Paola G, Mastorakos E EXPERIMENTAL THERMAL AND FLUID SCIENCE, 31(5), 393-401, 2007
4. Simulations of spray autoignition and flame establishment with two-dimensional CMC Wright YM, De Paola G, Boulouchos K, et al. COMBUSTION AND FLAME, 143(4), 402-419, 2005
5. Experiments and Simulations of n-Heptane Spray Auto-Ignition in a Closed Combustion Chamber at Diesel Engine Conditions Yuri M. Wright, Ourania-Nektaria Margari, Konstantinos Boulouchos, Giorgio De Paola and Epaminondas Mastorakos FLOW TURBULENCE AND COMBUSTION, to appear 2009. Available online from <http://www.springerlink.com/content/100237/?Content+Status=Accepted>

To view the winning thesis please go to;
<http://www-diva.eng.cam.ac.uk/theses.html>.

Call for nominations 2011

Nominations are sought from PhD supervisors for candidates for the 2011 prize. A thesis abstract and/or supporting letter or statement are required for nomination. An electronic copy of any shortlisted thesis should be provided for assessment at the final stage.

Nominations should be sent to: Combustion.Group@gmail.com, quoting "Lefebvre Award Nomination" in the subject field. The closing date for nominations is **31 August 2011**. Selection will be by a sub-committee of the Combustion Physics Group committee. The winner will be announced at the Early Career Researchers' meeting (September 2011), following the Combustion Physics Group AGM.

Terms

This award will be judged on the significance of the contribution and difficulties overcome.

It is awarded biennially (awarded for the first time in 2009). The prize is £250 and shall be accompanied by a certificate.

Eligibility

Any PhD thesis published or examined by a UK or Irish University from 1 January 2008 to 31 December 2010 is eligible for the award.

The PhD can be in any field of combustion physics; diagnostics, measurements, computation, etc.

If you require future information please contact the committee on Combustion.Group@gmail.com.

Huw Edwards Prize for Services to Combustion 2010 is awarded to Prof. Ken Bray.

The Huw Edwards prize for services to combustion is named after the late Prof. D. Huw Edwards, a world renowned scientist specifically interested in the phenomenon of detonations. Reviewed annually, but not necessarily awarded every year, the prize is awarded for either an important contribution to the field of combustion physics over a prolonged period of time, e.g. leading a strong research group over many years or a substantial contribution to education and training or otherwise raising the profile of combustion, for example by exemplary teaching in academia, or, successfully working with the popular media. The recipient may work in any field of combustion physics, for any individual or team based in the UK or Ireland and nominations are sought from academia and industry. It gives the Combustion Physics Group great pleasure to award this prize to Prof. Ken Bray.

We intend to hold a presentation event in June at Imperial College London, and we hope you will join us for a celebratory dinner in Prof. Ken Bray's honour. More

details will be circulated and posted on our website (see contact details below) nearer to the time.

4.2 Contact details

Web Page: <http://www.iop.org/activity/groups/subject/comb/>

Committee:

Chair: **Professor Philip Bowen**
(BowenPJ@Cardiff.ac.uk)

Vice-Chair: **Mr Graham Pitcher**
(gpitcher@lotuscars.co.uk)

Secretary/Treasurer: **Dr Catherine Gardner**
(catherine.gardner@qmul.ac.uk)

Ordinary Members:

Dr Andrew Clarke (A.Clarke@lboro.ac.uk)
Mrs Kathryn Kroon (lkskrook@loughhs.leics.sch.uk)
Professor Kai Luo (K.H.Luo@soton.ac.uk)
Dr Nigel Tait (nigel.tait@shell.com)
Dr Baixin Chen (B.Chen@hw.ac.uk)
Dr Guillermo Rein (G.Rein@ed.ac.uk)
Dr Rama Balachandran (r_balachndrn@meng.ucl.ac.uk)
Professor Yannis Hardalupas (y.hardalupas@imperial.ac.uk)

Co-opted Members

Mr Ralph Boyce (ralph.boyce@rolls-royce.com)
Ms Catherine Goy (Catherine.Goy@Eon-Engineering.com)

This newsletter is also available on the web and in larger print sizes

The contents of this newsletter do not necessarily represent the views or policies of the Institute of Physics, except where explicitly stated.

The Institute of Physics, 76 Portland Place, W1B 1NT, UK.

Tel: 020 7470 4800

Fax: 020 7470 4848